

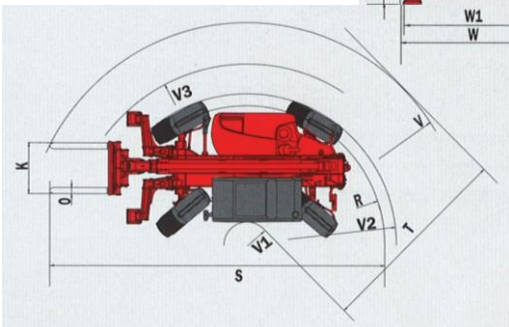

# MANITOU MT 1030S

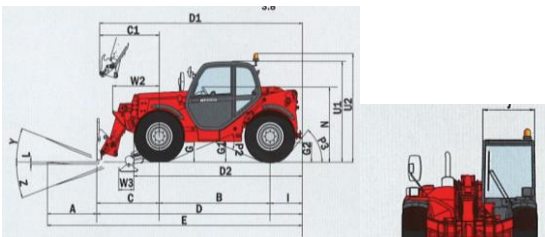
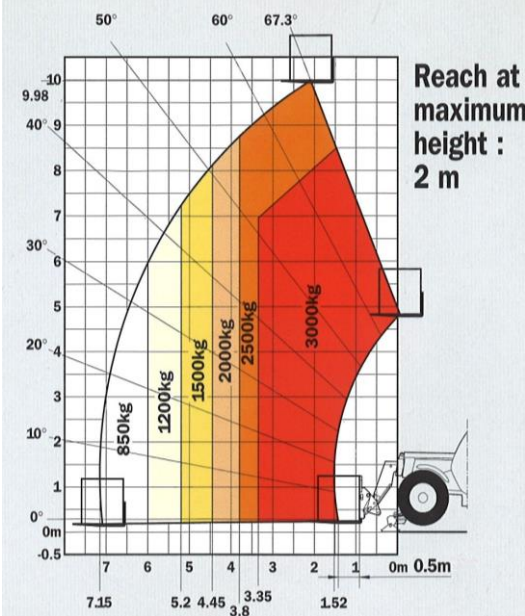

	mm
A	1200
B	2690
C	1513
C1	1450
D	4988
D1	4935
D2	4070
E	6198
F	1846
G	460
G1	440
G2	445
G3	220
I	795
J	865
K	1040
L	45
N	1690
O	125
P2	44°
P3	53°
R	3545
S	7808
T	3670
U1	2300
U2	2550
V	4950
V1	1280
V2	3750
V3	4200
W	2261
W1	2210
W2	1132
W3	340
Y	12°
Z	114°

## MT 1030 S

 **Lifting capacity** .....3000 kg  
 at 500 mm from forks heels.  
 Tipping load at maximum reach .....1160 kg  
 Tear at force with toothed digging bucket (Iso 8313 - 1986).....5330 daN

 **Lifting height** .....9.98 m  
**Times : Unladen/loaded (in s)**  
 Lifting.....6.7/9  
 Lowering.....5.2/5.4  
 Simultaneous extension 1<sup>st</sup> and 2<sup>nd</sup> booms.....13.8/14.2  
 Simultaneous retraction 1<sup>st</sup> and 2<sup>nd</sup> booms .....8.6/7.3  
 Time unladen (in s)  
 Crowding.....3  
 Dumping .....2.5

 **Tyres**  
 15.5/80 - 24 12 PR

 **Forks (mm)**  
 Length .....1200  
 Width x thickness .....125 X 45  
 Maximum distance between forks.....1040  
 Carriage rotation .....126°

 **Hydraulically operated brakes**  
 with oil-immersed muldisks on both axes

 **PERKINS Engine**  
 Type .....1104C-44  
 Capacity .....4 cyl. 4400 cm<sup>3</sup>  
 Power (ISO 14396) : .....82 HP/61.5 kw  
 Maximum torque : .....302 Nm at 1400 rpm  
 Direct injection  
 Water cooling

 **Transmission** .....Torque Converter  
 Electro - Hydraulic reversing shift  
 4 gears forward and reverse  
 Maximum travel speed .....25 km/h

 **Hydraulics**  
 Lifting/tilting pump  
 gear type : .....250 bars /105 l/mn  
 Flow divider with priority to steering and brakes.

 **Capacities**  
 Cooling system .....24.5 l.  
 Engine oil .....10.5 l.  
 Hydraulic oil .....125 l.  
 Transmission oil.....15.5 l.  
 Fuel tank.....120 l.

 **Weight unladen (with forks)** .....7470 kg  
**Overall width** .....2.26 m  
**Overall height** .....2.30 m  
**Turning radius (outside wheels)** .....3.75 m  
**Length up to carriage** .....4.98 m  
**Ground clearance** .....0.44 m  
**Drawbar pull** .....7350 daN

### Standard :

- Beacon
- Floating forks carriage
- Attachment hydraulic line
- Reverse alarm and lights

### Options :

- Wide range of attachments (buckets, jibs, made to measure attachments)
- Air conditioning
- Work lights
- ...