

MANITOU MT 1235S



MARSH PLANT®

NEW LANE, HAVANT, HAMPSHIRE, PO9 2LZ

Telephone 023 9248 2323

www.marshplant.com

Millbrook Road, Southampton
Hampshire, SO15 0LB
Telephone 023 8052 2600
southampton@marshplant.com

Drakes Drive, longCrendon
Aylesbury, HP18 9BA
Telephone 01844 204000
longcrendon@marshplant.com

Cabot Lane, Creekmoor, Poole
Dorset BH17 7BX
Telephone 01202 642820
poole@marshplant.com

7b Watercombe Park
Gazelle Road, Yeovil
Somerset, BA20 2HL
Telephone 01935 415970
yeovil@marshplant.com

Wallingford Road, Uxbridge
Middlesex UB8 2SS
Telephone 01844 204000
longcrendon@marshplant.com

MT 1235 S/S/T

 **Lifting capacity**3500 kg
at 500 mm for forks heels.
Tipping load at maximum reach :1460 kg
Tear out force with bucket
to ISO 8313.....7000 daN

 **Lifting height** :12 m
Times : unladen / loaded (in s)
Lifting10.8/11.2
Lowering7.3/7
Simultaneous extension 1st and 2nd booms..22.6/22.9
Simultaneous retraction 1st and 2nd booms..17.4/16.7
Time unladen (in s)
Crowd4.3
Dump3.4

 **Tyres**
400/80 -24 TL 156 B

 **Forks** (mm)
Length.....1200
Width x thickness.....125 X 45
Maximum distance between forks.....1040
Carriage rotation.....124°

 **Multidisc brakes - hydraulically assisted on both axles**

 **PERKINS Engine**
Type.....1104C.44/1104C.44 Turbo
Capacity.....4 cylindres - 4400 cm³
Power (ISO/TR 14396) :82 HP/61.5 kw
at 2200 rpm Turbo :100 HP/74.5 kw
Maximum torque302 Nm at 1400 rpm
Turbo :412 Nm at 1400 rpm
Direct Injection
Water Cooling

 **Transmission**Torque convertor
Electro-hydraulic reversing shift
4 speeds forward and reverse
Maximum travel speed.....25 km/h

 **Hydraulics**
Lifting/tilting pump
gear type:260 bars/105 l/mn
Flow divider with priority to steering and brakes

 **Capacities**
Cooling system18.5 l.
Engine oil.....10.5 l. (Turbo 11 l.)
Hydraulic oil.....120 l.
Transmission oil.....16 l.
Fuel tank135 l.

 **Weight unladen** (with forks)8960 kg
Overall width2.40 m
Overall height2.57 m
Turning radius (outside wheels)4.15 m
Overall length5.59 m
Ground clearance0.45 m
Drawbar pull7500/8600 daN

Reach at maximum height : 1.5 m

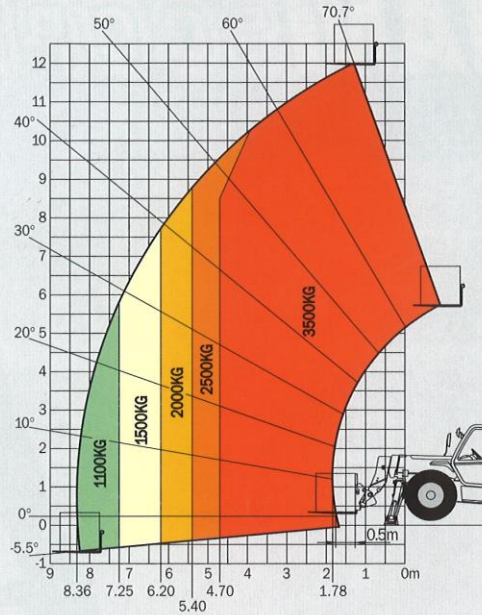

Under
EN 1459
annexe B

A	1200
B	2770
C	1770
C1	1850
D	5590
D1	5670
D2	4405
E	6790
F	1990
F1	1990
G	450
G1	445
G2	450
G3	275
I	1050
J	950
K	1040
L	45
N	1850
O	125
P2	43,5°
P3	40°
R	3950
S	8513
T	3920
U1	2575
U2	2755
V	5390
V1	1470
V2	4158
W	2405
W1	2320
W2	1125
W3	2035
Y	12°
Z	112°

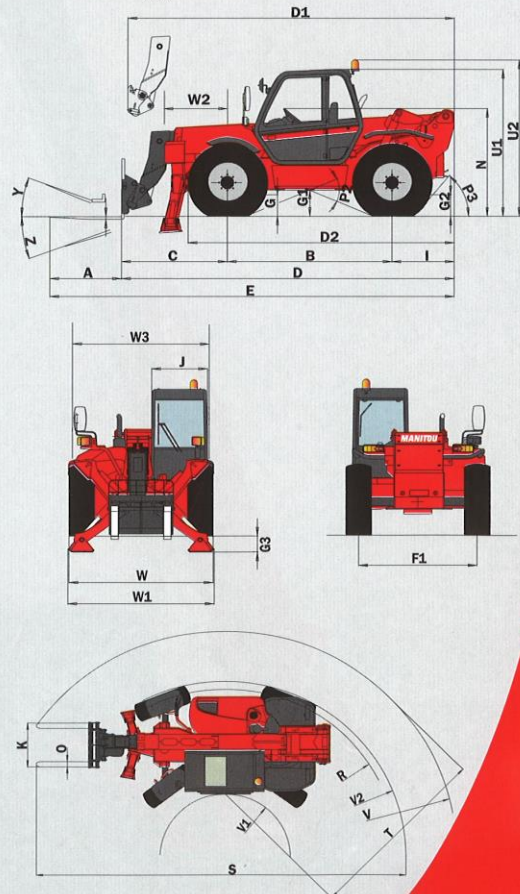

This publication in no way constitutes an offer and the company reserves the right to alter specification without prior notice.
The MANITOU models presented in this brochure can be supplied complete with optional equipment attachments.
PATENTS FR 93 14367 - EP 0 656 315 US PENDING



MANITOU BF SA
B.P. 249 - 44158 Ancenis Cedex - France
Tél. : 33 2 40 09 10 11 / Export Department Fax : 33 2 40 09 10 97
www.manitou.com

700024EN - BI 202/Ind. D

