

MANITOU MT 625T



MARSH PLANT®

NEW LANE, HAVANT, HAMPSHIRE, PO9 2LZ
Telephone 023 9248 2323

Millbrook Road, Southampton
Hampshire, SO15 0LB
Telephone 023 8052 2600
southampton@marshplant.com

www.marshplant.com

Drakes Drive, longCrendon
Aylesbury, HP18 9BA
Telephone 01844 204000
longcrendon@marshplant.com

Cabot Lane, Creekmoor, Poole
Dorset BH17 7BX
Telephone 01202 642820
poole@marshplant.com

7b Watercombe Park
Gazelle Road, Yeovil
Somerset, BA20 2HL
Telephone 01935 415970
yeovil@marshplant.com

Wallingford Road, Uxbridge
Middlesex UB8 2SS
Telephone 01844 204000
longcrendon@marshplant.com

MT 625 T

 **Lifting capacity** 2500 kg
 at 500 mm from forks heels
 Tipping load at max reach 1040 kg
 Break out force
 as per standard ISO 8313-1986 3427 daN

 **Lifting height** 5.85 m
Time: laden/unladen (in s)
 Lifting 8/8
 Lowering 5.4/5.3
 Telescope
 Extension 5.6/5.9
 Retraction 4.3/4
 Time unladen (in s)
 Crowd 3.5
 Dump 3.6

 **Front/rear tyres**
 12-16.5 SKS CL TUBELESS

 **Forks (mm)**
 Length 1200
 Width x thickness 125 x 45

 **Oil immersed multidisc brake**

 **KUBOTA engine**
Type V3307-DI-T-E3B
Capacity 4 cylindres/3331 cm³
Power (ISO/TR 14396)
 Turbo 75 hp/55.4 kW
 Max. torque. (ISO/TR 14396) 265 Nm at 1400 tr/mn
Injection direct
Cooling water

 **Transmission** hydrostatic
 Gear reverser electro - hydraulic
 Speed forward and reverse 2/2

 **Hydraulics**
 Gear pump 87.9 l./mn at 235 bar
 Flow divider priority for steering

 **Capacities**
 Cooling system 12 l.
 Transmission oil 85 l.
 Engine oil 11.2 l.
 Fuel tank 63 l.

 **Empty weight (with forks)** 4710 kg
Overall Width 1.82 m
Overall Height 1.92 m
Turning radius (outer wheels) 3.30 m
Length at carriage 3.90 m
Ground clearance 0.33 m
Drawbar pull 4170 daN

The indicated specifications are not binding on the maker and may be modified without notice.
 The Manitou trucks presented in this brochure may be fitted with optional items of equipment.

Maximum height reach: 0.66 m

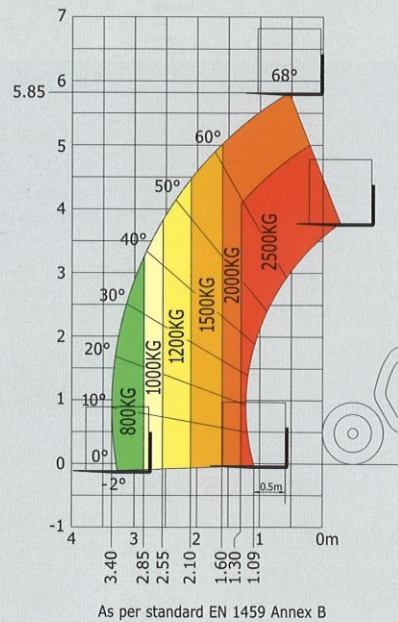

MT 625 T

A	1200
B	2300
C	991
C1	928
D	3894
D1	3831
D2	3275
E	5094
F	1492
F1	1492
G	240
G1	330
G2	253
I	603
J	797
K	1015
L	45
N	1314
O	125
P2	37
P3	52
R	3150
S	6651.5
T	3935
U1	1920
U2	2054
V	4700
V1	765
V2	3310.5
W	1813
Y	11.8°
Z	116.5°

(mm)

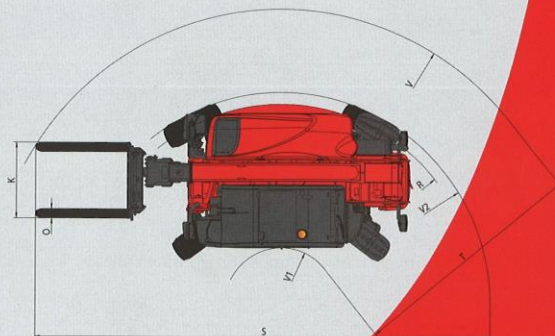
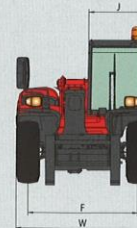
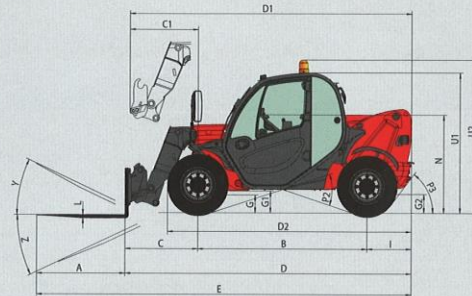

MANITOU BF SA
 B.P. 249 - 44158 Ancenis Cedex - France
 Tel. : 33 2 40 09 10 11 / Export Department Fax : 33 2 40 09 10 97
 www.manitou.com

700441EN_A_0210_MT625T.indd - BE527 Indice C

